

UAR/T: Universal Asynchronous Receiver/Transmitter

FEATURES

- DTL and TTL compatible—no interfacing circuits required—drives one TTL load
- Fully Double Buffered—eliminates need for system synchronization, facilitates high-speed operation
- Full Duplex Operation—can handle multiple bauds (receiving-transmitting) simultaneously
- Start Bit Verification—decreases error rate with center sampling
- Receiver center sampling of serial input; 46% distortion immunity
- High Speed Operation
- Three-State Outputs—bus structure capability
- Low Power — minimum power requirements
- Input Protected—eliminates handling problems

AY-5-1013A

- GIANT P-channel nitride process
- 0 to 40kbaud
- Pull up resistors to  $V_{CC}$  on all inputs

AY-6-1013

- GIANT P-channel nitride process
- 0 to 22.5kbaud
- Extended Operating Temperature Range:  
-40°C to +85°C (plastic package)  
-55°C to +125°C (ceramic package)
- Pull-up resistors to  $V_{CC}$  on all inputs

AY-3-1014A/1015D

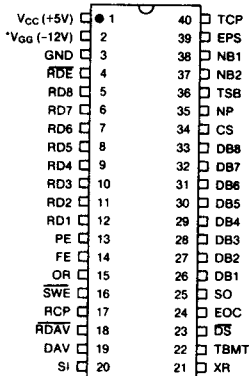
- Single Supply Operation:  
+4.75V to +14V (AY-3-1014A)  
+4.75V to +5.25V (AY-3-1015D)
- CMOS compatible (AY-3-1014A)
- 1½ stop bit mode
- External reset of all registers except control bits register
- GIANT II N-channel Ion Implant Process
- 0 to 30k baud
- Pull-up resistors to  $V_{CC}$  on all inputs (AY-3-1015D)

DESCRIPTION

The Universal Asynchronous Receiver/Transmitter (UAR/T) is an LSI subsystem which accepts binary characters from either a terminal device or a computer and receives/transmits this character with appended control and error detecting bits. All characters contain a start bit, 5 to 8 data bits, one or two stop bits (1½ stop bit capability with the AY-3-1014A/1015D), and either odd/even parity or no parity. In order to make the UAR/T universal, the baud, bits per word, parity mode, and the number of stop bits are externally selectable. The device is constructed on a single monolithic chip. All inputs and outputs are directly compatible with MTOS/MTNS logic, and also with TTL/DTL/CMOS logic without the need for interfacing components. All strobed outputs are three-state logic.

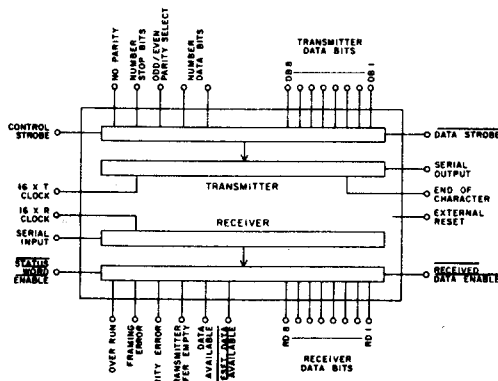
PIN CONFIGURATION  
40 LEAD DUAL IN LINE

Top View



\* Pin 2: AY-3-1014A/1015D — No Connection.

BLOCK DIAGRAM





PIN FUNCTIONS

Pin No.	Name (Symbol)	Function															
1	V <sub>CC</sub> Power Supply (V <sub>CC</sub> )	+5V Supply															
2	V <sub>EE</sub> Power Supply (V <sub>EE</sub> )	-12V Supply (Not connected for AY-3-1014A/1015)															
3	Ground (V <sub>EE</sub> )	Ground															
4	Received Data Enable ( $\overline{RDE}$ )	A logic "0" on the receiver enable line places the received data onto the output lines.															
5-12	Received Data Bits (RD8-RD1)	These are the 8 data output lines. Received characters are right justified; the LSB always appears on RD1. These lines have tri-state outputs; i.e., they have the normal TTL output characteristics when RDE is "0" and a high impedance state when RDE is "1". Thus, the data output lines can be bus structure oriented.															
13	Parity Error (PE)	This line goes to a logic "1" if the received character parity does not agree with the selected parity. Tri-state.															
14	Framing Error (FE)	This line goes to a logic "1" if the received character has no valid stop bit. Tri-state.															
15	Over-Run (OR)	This line goes to a logic "1" if the previously received character is not read (DAV line not reset) before the present character is transferred to the receiver holding register. Tri-state.															
16	Status Word Enable ( $\overline{SWE}$ )	A logic "0" on this line places the status word bits (PE, FE, OR, DAV, TBMT) onto the output lines. Tri-state.															
17	Receiver Clock (RCP)	This line will contain a clock whose frequency is 16 times (16X) the desired receiver baud.															
18	Reset Data Available ( $\overline{RDAV}$ )	A logic "0" will reset the DAV line. The DAV F/F is only thing that is reset. Must be tied to logic "1" when not in use on the AY-3-1014A.															
19	Data Available (DAV)	This line goes to a logic "1" when an entire character has been received and transferred to the receiver holding register. Tri-state. Fig. 12, 34.															
20	Serial Input (SI)	This line accepts the serial bit input stream. A Marking (logic "1") to spacing (logic "0") transition is required for initiation of data reception. Fig. 11, 12, 33, 34.															
21	External Reset (XR)	Resets all registers except the control bits register (the received data register is not reset in the AY-5-1013A and AY-6-1013). Sets SO, EOC, and TBMT to a logic "1". Resets DAV, and error flags to "0". Clears input data buffer. Must be tied to logic "0" when not in use.															
22	Transmitter Buffer Empty (TBMT)	The transmitter buffer empty flag goes to a logic "1" when the data bits holding register may be loaded with another character. Tri-state. See Fig. 18, 20, 40, 42.															
23	Data Strobe ( $\overline{DS}$ )	A strobe on this line will enter the data bits into the data bits holding register. Initial data transmission is initiated by the rising edge of $\overline{DS}$ . Data must be stable during entire strobe.															
24	End of Character (EOC)	This line goes to a logic "1" each time a full character is transmitted. It remains at this level until the start of transmission of the next character. See Fig. 17, 19, 39, 41.															
25	Serial Output (SO)	This line will serially, by bit, provide the entire transmitted character. It will remain at a logic "1" when no data is being transmitted. See Fig. 16.															
26-33	Data Bit Inputs (DB1-DB8)	There are up to 8 data bit input lines available.															
34	Control Strobe (CS)	A logic "1" on this lead will enter the control bits (EPS, NB1, NB2, TSB, NP) into the control bits holding register. This line can be strobed or hard wired to a logic "1" level.															
35	No Parity (NP)	A logic "1" on this lead will eliminate the parity bit from the transmitted and received character (no PE indication). The stop bit(s) will immediately follow the last data bit. If not used, this lead must be tied to a logic "0".															
36	Number of Stop Bits (TSB)	This lead will select the number of stop bits, 1 or 2, to be appended immediately after the parity bit. A logic "0" will insert 1 stop bit and a logic "1" will insert 2 stop bits. For the AY-3-1014A/1015, the combined selection of 2 stop bits and 5 bits/character will produce 1½ stop bits.															
37-38	Number of Bits/Character (NB2, NB1)	These two leads will be internally decoded to select either 5, 6, 7 or 8 data bits/character. <table border="1" style="margin-left: auto; margin-right: auto;"> <thead> <tr> <th>NB2</th> <th>NB1</th> <th>Bits/Character</th> </tr> </thead> <tbody> <tr> <td>0</td> <td>0</td> <td>5</td> </tr> <tr> <td>0</td> <td>1</td> <td>6</td> </tr> <tr> <td>1</td> <td>0</td> <td>7</td> </tr> <tr> <td>1</td> <td>1</td> <td>8</td> </tr> </tbody> </table>	NB2	NB1	Bits/Character	0	0	5	0	1	6	1	0	7	1	1	8
NB2	NB1	Bits/Character															
0	0	5															
0	1	6															
1	0	7															
1	1	8															
39	Odd/Even Parity Select (EPS)	The logic level on this pin selects the type of parity which will be appended immediately after the data bits. It also determines the parity that will be checked by the receiver. A logic "0" will insert odd parity and a logic "1" will insert even parity.															
40	Transmitter Clock (TCP)	This line will contain a clock whose frequency is 16 times (16X) the desired transmitter baud.															

TELECOM



## UART GENERAL INFORMATION

### TRANSMITTER OPERATION

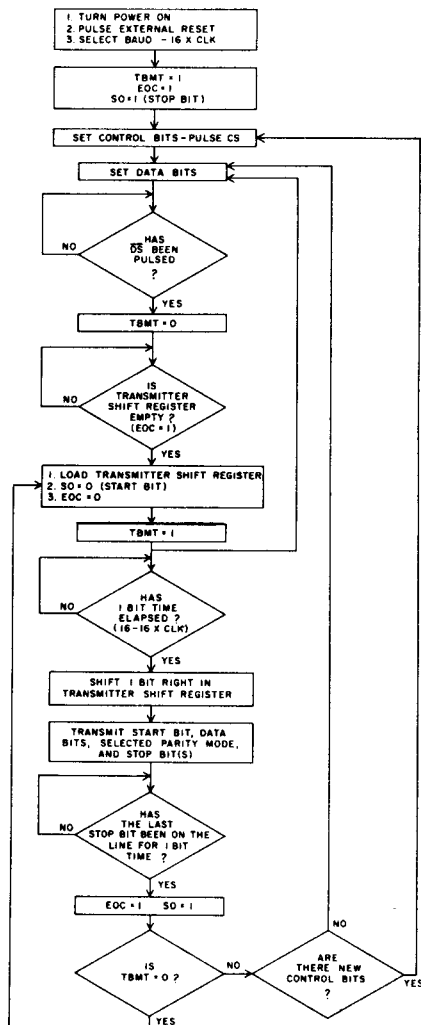


Fig. 1

#### Initializing

Power is applied, external reset is enabled and clock pulse is applied having a frequency of 16 times the desired baud. The above conditions will set TBMT, EOC, and SO to logic "1" (line is marking).

After initializing is completed, user may set control bits and data bits with control bits selection normally occurring before data bits selection. However, one may set both  $\overline{DS}$  and CS simultaneously if minimum pulse width specifications are followed. Once Data Strobe (DS) is pulsed the TBMT signal will change from a logic "1" to a logic "0" indicating that the data bits holding register is filled with a previous character and is unable to receive new data bits, and transmitter shift register is transmitting previously loaded data. TBMT will return to a logic "1". When transmitter shift register is empty, data bits in the holding register are immediately loaded into the transmitter shift register for transmission. The shifting of information from the holding register to the transmitter shift register will be followed by SO and EOC going to a logic "0", and TBMT will also go to a logic "1" indicating that the shifting operation is completed and that the data bits holding register is ready to accept new data. It should be remembered that one full character time is now available for loading of the next character without loss in transmission speed due to double buffering (separate data bits holding register and transmitter shift register).

Data transmission is initiated with transmission of a start bit, data bits, parity bit (if desired) and stop bit(s). When the last stop bit has been on line for one bit time, EOC will go to a logic "1" indicating that new character is ready for transmission. This new character will be transmitted only if TBMT is a logic "0" as was previously discussed.



RECEIVER OPERATION

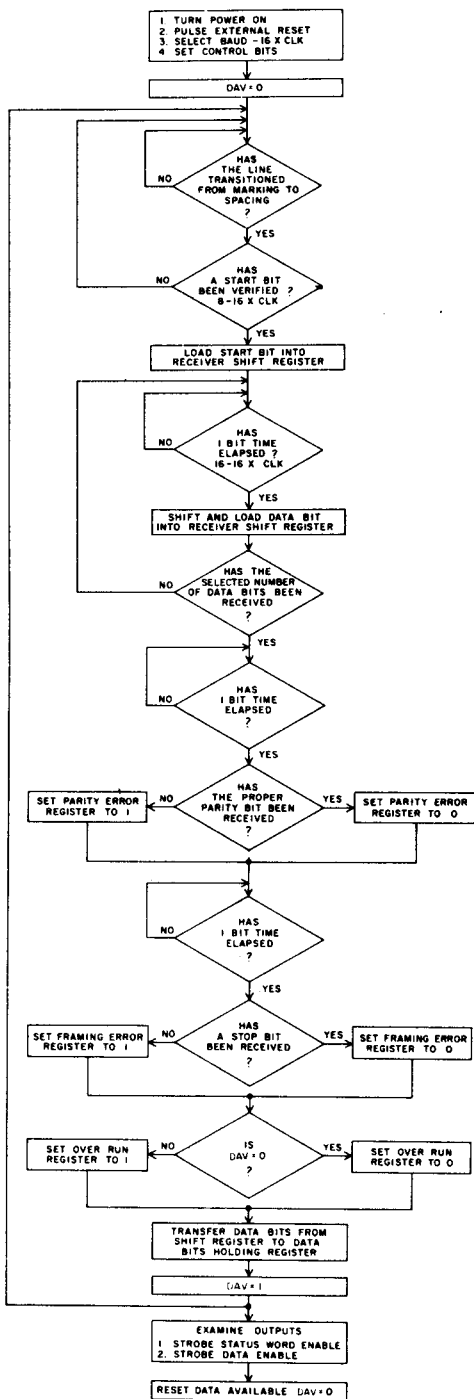


Fig.2

Initializing

Power is applied, external reset is enabled, and clock pulse is applied having a frequency of 16 times the desired baud. The previous conditions will set data available (DAV) to a logic "1".

After initializing is completed, user should note that one set of control bits will be used for both receiver and transmitter making individual control bit setting unnecessary. Data reception starts when serial input signal changes from Marking (logic "1") to spacing (logic "0") which initiates start bit. The start bit is valid if, after transition from logic "1" to logic "0", the SI line continues to be at logic "0", when center sampled, 8 clock pulses later. If, however, line is at a logic "1" when center sampling occurs, the start bit verification process will be reset. If the Serial Input line transitions from a logic "1" to a logic "0" (marking to spacing) when the 16x clock is in a logic "1" state, the bit time, for center sampling will begin when the clock line transitions from a logic "1" to a logic "0" state. After verification of a genuine start bit, data bit reception, parity bit reception and stop bit(s), reception proceeds in an orderly manner.

While receiving parity and stop bit(s) the receiver will compare transmitted parity and stop bit(s) with control data bits (parity and number of stop bits) previously set and indicate an error by changing the parity error flip flop and/or the framing error flip flop to a logic "1". It should be noted that if the No Parity Mode is selected the PE (parity error) will be unconditionally set to a logic "0".

Once a full character is received, internal logic looks at the data available (DAV) signal to determine if data has been read out. If the DAV signal is at a logic "1" the receiver will assume data has not been read out and the over run flip flop of the status word holding register will be set to a logic "1". If the DAV signal is at a logic "0" the receiver will assume that data has been read out. After DAV goes to a logic "1", the receiver shift register is now ready to accept the next character and has one full character time to remove the received character.

TELECOM

UAR/T GENERAL INFORMATION

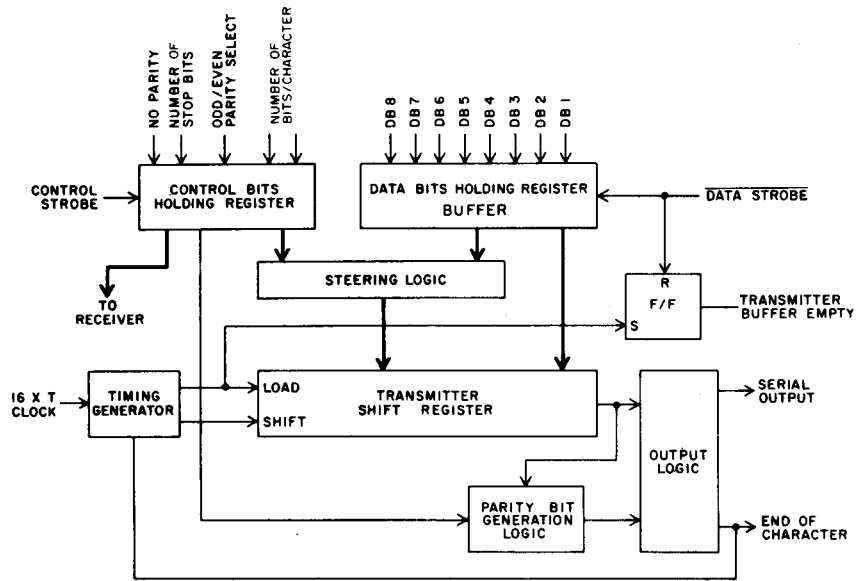


Fig.3 TRANSMITTER BLOCK DIAGRAM

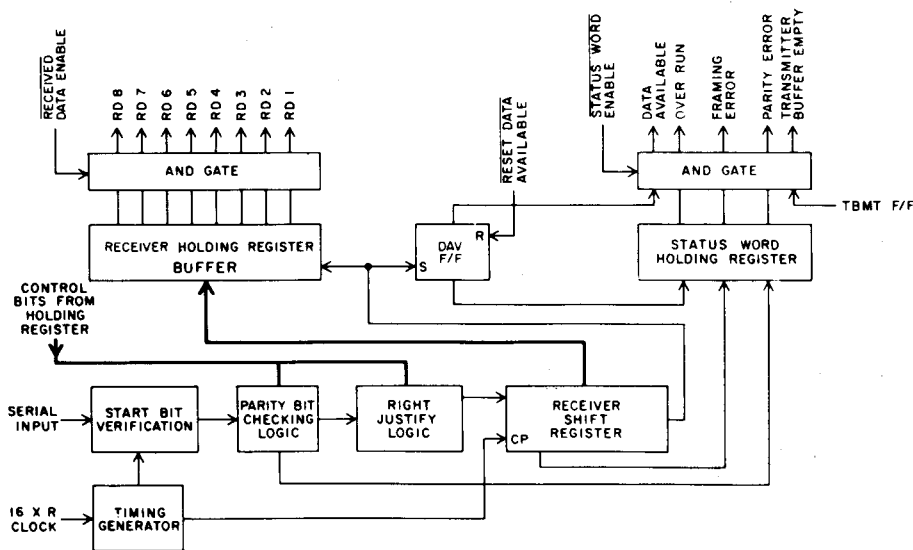


Fig.4 RECEIVER BLOCK DIAGRAM

**ELECTRICAL CHARACTERISTICS**

**Maximum Ratings\***

V <sub>GG</sub> (with respect to V <sub>CC</sub> )	-20 to +0.3V
Clock and logic input voltages (with respect to V <sub>CC</sub> )	-20 to +0.3V
Storage Temperature	-65°C to +150°C
Lead Temperature (soldering, 10 seconds)	+330°C

\*Exceeding these ratings could cause permanent damage. Functional operation of these devices at these conditions is not implied —operating ranges are specified below.

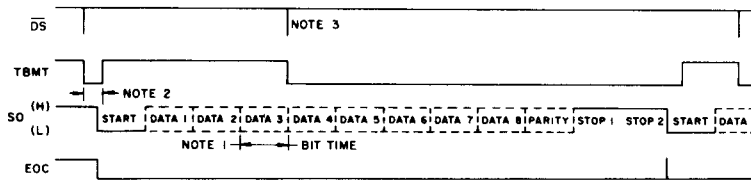
**Standard Conditions** (unless otherwise noted)

V <sub>GG</sub>	= -12V ±5%
V <sub>CC</sub>	= +5V ±5%
Temperature (T <sub>A</sub> )	= 0°C to +70°C (AY-5-1013A)
	-40 C to +85°C (AY-6-1013 Plastic Package)
	-55C to +125°C (AY-6-1013 Ceramic Package)

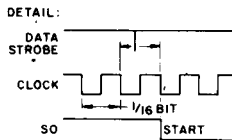
Characteristic	Min	Typ**	Max	Units	Conditions
<b>DC CHARACTERISTICS</b>					
<b>Input Logic Levels</b>					
Logic 0	0	—	0.8	Volts	(I <sub>IL</sub> = -1.6mA max.) Unit has internal pullup resistors
Logic 1	V <sub>CC</sub> -1.5	—	V <sub>CC</sub> +0.3	Volts	
<b>Input Capacitance</b>					
All Inputs	—	—	20	pF	0 volts bias, f= 1MHz
<b>Leakage Currents</b>					
Three State Outputs	—	—	1.0	μA	0 volts
<b>Data Output Levels</b>					
Logic 0	—	—	+0.4	Volts	I <sub>OL</sub> = 1.6mA (sink) } at 5.0 Volts I <sub>OH</sub> = .3mA (source) }
Logic 1	V <sub>CC</sub> -1.0	—	—	Volts	
<b>Output Capacitance</b>					
	—	10	15	pF	
<b>Short Ckt. Current</b>					
	—	—	—	—	See Fig. 23
<b>Power Supply Current</b>					
I <sub>GG</sub>	—	14	16	mA	AY-5-1013A - See Fig.25 AY-6-1013 - See Fig.25 AY-5-1013A - See Fig.26 AY-6-1013
I <sub>CC</sub>	—	17	19	mA	
	—	18	20	mA	
	—	21	23	mA	
<b>AC CHARACTERISTICS</b>					
T <sub>A</sub> = 25°C, output load capacitance 50pF max.					
<b>Clock Frequency</b>					
	DC	—	640	kHz	AY-5-1013A
	DC	—	360	kHz	AY-6-1013
<b>Baud</b>					
	0	—	40	kbaud	AY-5-1013A
	0	—	22.5	kbaud	AY-6-1013
<b>Pulse Width</b>					
<b>Clock Pulse</b>					
	750	—	—	ns	AY-5-1013A - See Fig.9
	1.5	—	—	μs	AY-6-1013-See Fig.9
<b>Control Strobe</b>					
	300	—	—	ns	AY-5-1013A-See Fig. 15, 16
	600	—	—	ns	AY-6-1013
<b>Data Strobe</b>					
	190	—	—	ns	AY-5-1013A-See Fig. 14
	250	—	—	ns	AY-6-1013
<b>External Reset</b>					
	500	—	—	ns	AY-5-1013A - See Fig. 13
	1.0	—	—	μs	AY-6-1016
<b>Status Word Enable</b>					
	500	—	—	ns	AY-5-1013A - See Fig. 21
	600	—	—	ns	AY-6-1013 - See Fig. 21
<b>Reset Data Available</b>					
	250	—	—	ns	AY-5-1013A - See Fig. 22
	350	—	—	ns	AY-6-1013 - See Fig. 22
<b>Received Data Enable</b>					
	500	—	—	ns	AY-5-1013A - See Fig. 21
	600	—	—	ns	AY-6-1013 - See Fig. 21
<b>Set Up &amp; Hold Time</b>					
<b>Input Data Bits</b>					
	0	—	—	ns	See Fig.14
<b>Input Control Bits</b>					
	0	—	—	ns	See Fig. 15, 16
<b>Output Propagation Delay</b>					
<b>TPD0</b>					
	—	—	500	ns	AY-5-1013A - See Fig. 21 & 24
	—	—	650	ns	AY-6-1013 - See Fig. 21 & 24
<b>TPD1</b>					
	—	—	500	ns	AY-5-1013A - See Fig. 21 & 24
	—	—	650	ns	AY-6-1013 - See Fig. 21 & 24

\*\*Typical values are at +25°C and nominal voltages.

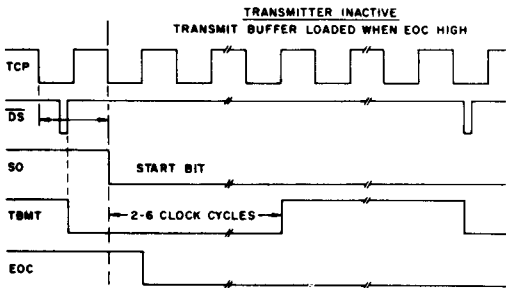
**TIMING DIAGRAMS**



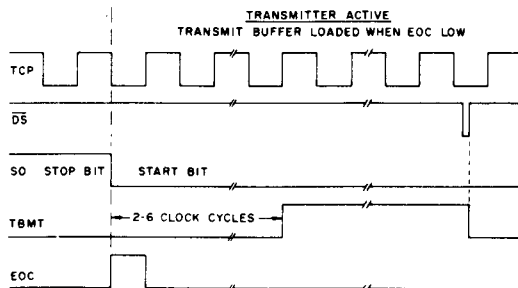
NOTE: SEE FIGURES 7, 8, 9 FOR DETAILS.  
 TRANSMITTER INITIALLY ASSUMED INACTIVE AT START OF DIAGRAM. SHOWN FOR 8 LEVEL CODE AND PARITY AND TWO STOPS.  
 1: BIT TIME = 16 CLOCK CYCLES.  
 2: IF TRANSMITTER IS INACTIVE THE START PULSE WILL APPEAR ON LINE WITHIN 1 CLOCK CYCLE OF TIME DATA STROBE OCCURS. SEE DETAIL.  
 3: SINCE TRANSMITTER IS DOUBLE BUFFERED ANOTHER DATA STROBE CAN OCCUR ANYWHERE DURING TRANSMISSION OF CHARACTER 1 AFTER TBMT GOES HIGH.



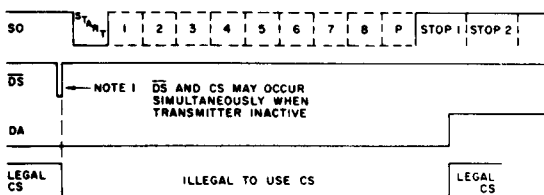
**Fig.5 UAR/T TRANSMITTER TIMING**



**Fig.6 TRANSMITTER AT START BIT**

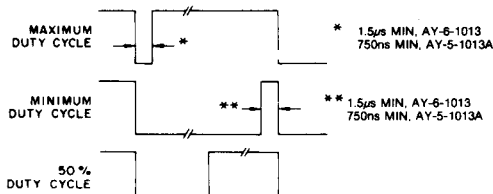


**Fig.7 TRANSMITTER AT START BIT**



NOTE. CONTROL STROBE MAY BE HARDWIRED TO "1" IN THAT CASE, DATA MUST BE STABLE DURING "ILLEGAL CS" TIME

**Fig.8 ALLOWABLE POINTS TO USE CONTROL STROBE**

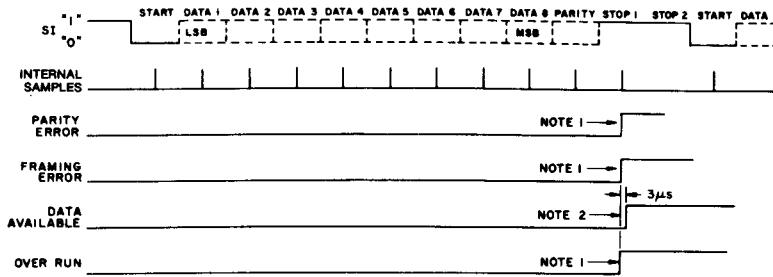


ANY PULSE WIDTH WHICH MEETS ABOVE CRITERIA IS ALLOWABLE

**Fig.9 ALLOWABLE TCP, RCP**

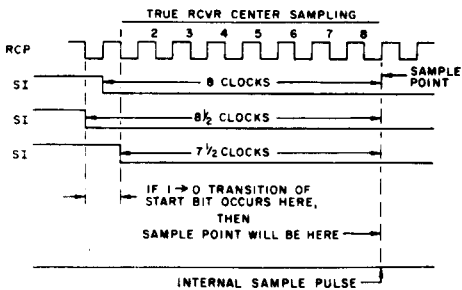


**TIMING DIAGRAMS**

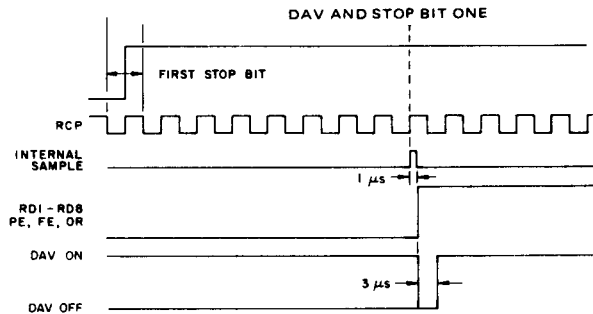


- NOTES:**
1. THIS IS THE TIME WHEN THE ERROR CONDITIONS ARE INDICATED, IF ERROR OCCURS.
  2. DATA AVAILABLE IS SET ONLY WHEN THE RECEIVED DATA, PE, FE, OR HAS BEEN TRANSFERRED TO THE HOLDING REGISTERS. (SEE RECEIVER BLOCK DIAGRAM).
  3. ALL INFORMATION IS GOOD IN HOLDING REGISTER UNTIL DATA AVAILABLE TRIES TO SET FOR NEXT CHARACTER.
  4. ABOVE SHOWN FOR 8 LEVEL CODE PARITY AND TWO STOP. FOR NO PARITY, STOP BITS FOLLOW DATA.
  5. FOR ALL LEVEL CODE THE DATA IN THE HOLDING REGISTER IS *RIGHT JUSTIFIED*; THAT IS, LSB ALWAYS APPEARS IN RD1 (PIN 12).

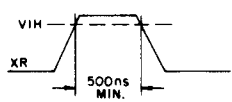
**Fig.10 UAR/T RECEIVER TIMING**



**Fig.11**

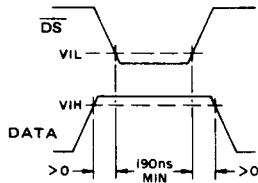


**Fig.12 RECEIVER DURING 1st STOP BIT**

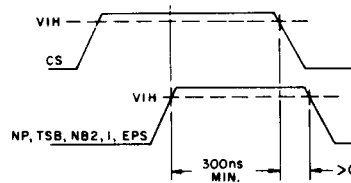


WHEN NOT IN USE, XR MUST BE HELD AT GND.  
 XR RESETS EVERY REGISTER EXCEPT CONTROL REGISTER AND RECEIVED DATA. SO, TRMT, EOC ARE RESET TO 5V ALL OTHER OUTPUTS RESET TO 0V.

**Fig.13 XR PULSE**

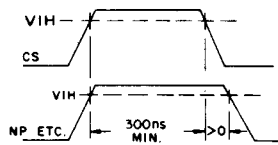


**Fig.14 DS**



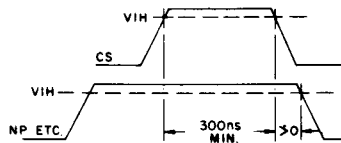
CONTROL BITS MUST BE STABLE FOR LAST 300ns OF CS.

**Fig.15a CS**



CONTROL STROBE AND CONTROL BITS MUST BE 300ns MINIMUM.

**Fig.15b CS**



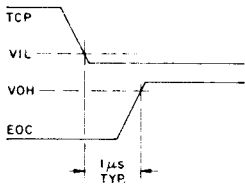
LEADING EDGE OF DATA IS NOT CRITICAL AS LONG AS TRAILING EDGE AND PULSE WIDTH SPECS ARE OBSERVED.

**Fig.16 CS**

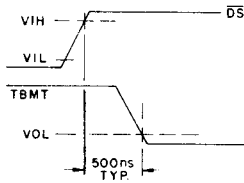
TELECOM



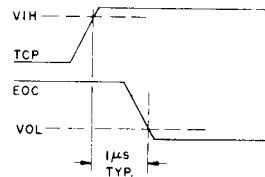
**TIMING DIAGRAMS**



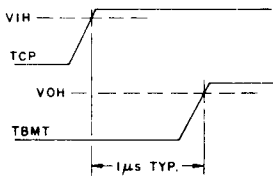
**Fig.17 EOC TURN-ON**



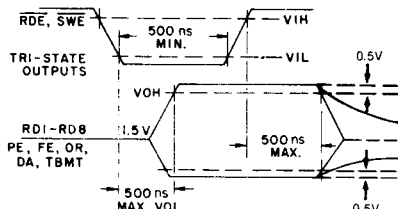
**Fig.18 TBMT TURN-OFF**



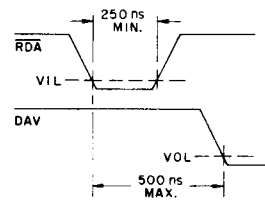
**Fig.19 EOC TURN-OFF**



**Fig.20 TBMT TURN-ON**

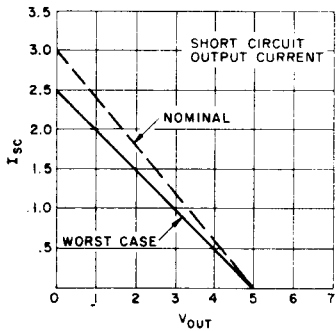


**Fig.21 RDE, SWE**

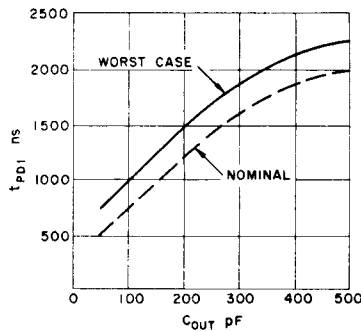


**Fig.22 RDAV**

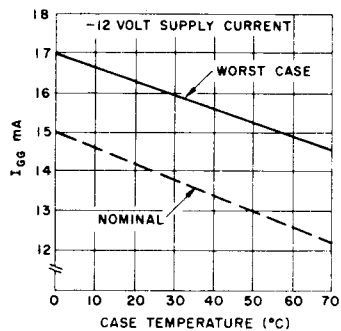
**TYPICAL CHARACTERISTIC CURVES**



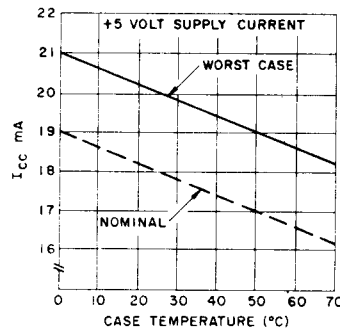
**Fig.23 SHORT CIRCUIT OUTPUT CURRENT**



**Fig.24 RE1, RD8, PE, FE, OR, TBMT, DAV**



**Fig.25 -12 VOLT SUPPLY CURRENT**



**Fig.26 +5 VOLT SUPPLY CURRENT**

# SPECIFICATIONS

## ELECTRICAL CHARACTERISTICS

### Maximum Ratings\*

V<sub>CC</sub> (with respect to GND) . . . . . -0.3 to +16V  
 Storage Temperature . . . . . -65°C to +150°C  
 Operating Temperature . . . . . 0°C to +70°C  
 Lead Temperature (Soldering, 10 sec) . . . . . +330°C

\*Exceeding these ratings could cause permanent damage. Functional operation of these devices at these conditions is not implied —operating ranges are specified below.

### Standard Conditions (unless otherwise noted)

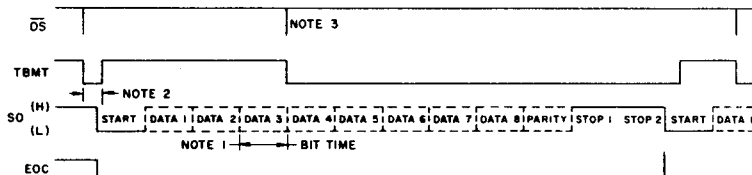
V<sub>CC</sub> = +4.75 to +14V (AY-3-1014A)  
 V<sub>CC</sub> = +4.75V to +5.25V (AY-3-1015D)  
 Operating Temperature (T<sub>A</sub>) = 0°C to +70°C

Characteristic	Min	Typ**	Max	Units	Conditions	
<b>DC CHARACTERISTICS</b>						
<b>Input Logic Levels (AY-3-1014A)</b>						
Logic 0	0	—	0.8	Volts	AY-3-1015 has internal pull-up resistors to V <sub>CC</sub> . 0 volts bias, f = 1MHz	
Logic 1: at V <sub>CC</sub> = +4.75V	2.0	—	V <sub>CC</sub> +0.3	Volts		
at V <sub>CC</sub> = +14V	3.0	—	V <sub>CC</sub> +0.3	Volts		
<b>Input Logic Levels (AY-3-1015)</b>						
Logic 0	0	—	0.8	Volts		
Logic 1	2.4	—	V <sub>CC</sub> +0.3	Volts		
<b>Input Capacitance</b>						
All inputs	—	—	20	pF		
<b>Output Impedance</b>						
Tri-State Outputs	1.0	—	—	MΩ		
<b>Data Output Levels</b>						
Logic 0	—	—	+0.4	Volts	I <sub>OL</sub> = 1.6mA (sink) I <sub>OH</sub> = -40μA (source)—at V <sub>CC</sub> = +5V I <sub>OH</sub> = -50μA (source)—at V <sub>CC</sub> = +14V	
Logic 1: AY-3-1014A/1015D	2.4	—	—	Volts		
AY-3-1014A only	3.5	—	—	Volts		
<b>Output Capacitance</b>						
Short Ckt. Current	—	10	15	pF	See Fig.45.	
<b>Power Supply Current</b>						
I <sub>CC</sub> at V <sub>CC</sub> = +5V (AY-3-1014A)	—	10	15	mA	See Fig.47.	
I <sub>CC</sub> at V <sub>CC</sub> = +14V (AY-3-1014A)	—	14	20	mA	See Fig.48.	
I <sub>CC</sub> at V <sub>CC</sub> = +5V (AY-3-1015D)	—	10	15	mA		
<b>AC CHARACTERISTICS</b>						
T <sub>A</sub> = 25°C, Output load capacitance 50 pF max.						
<b>Clock Frequency</b>	DC	—	480/400	kHz	at V <sub>CC</sub> = +4.75V/+14V	
<b>Baud</b>	0	—	30/25	kbaud	at V <sub>CC</sub> = +4.75V/+14V	
<b>Pulse Width</b>						
Clock Pulse	1.0	—	—	μs	See Fig.31	
Control Strobe	500	—	—	ns	See Fig.37	
Data Strobe	200	—	—	ns	See Fig.36	
External Reset	500	—	—	ns	See Fig.35	
Status Word Enable	500	—	—	ns	See Fig.43	
Reset Data Available	200	—	—	ns	See Fig.44	
Received Data Enable	500	—	—	ns	See Fig.43	
<b>Set Up &amp; Hold Time</b>						
Input Data Bits	20	—	—	ns	See Fig.36	
Input Control Bits	20	—	—	ns	See Fig.37	
<b>Output Propagation Delay</b>						
TPD0	—	—	500	ns	See Fig.43 & 46	
TPD1	—	—	500	ns	See Fig.43 & 46	

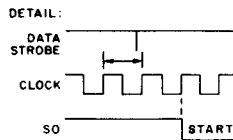
\*\*Typical values are at +25°C and nominal voltages.

TELECOM

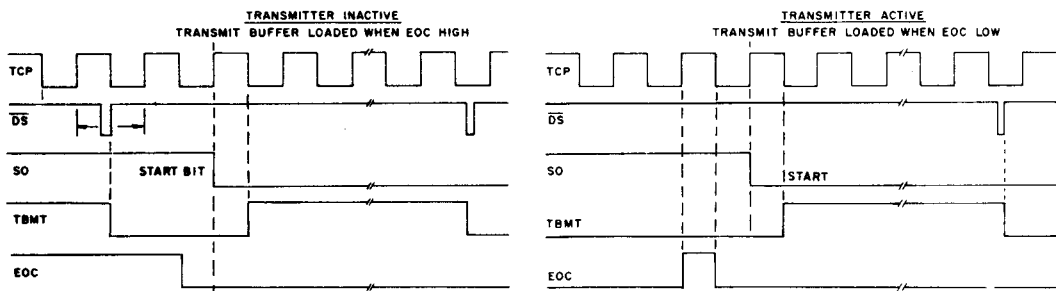
**TIMING DIAGRAMS**



NOTE: SEE FIGURES 28, 29, 30 FOR DETAILS.  
 TRANSMITTER INITIALLY ASSUMED INACTIVE AT START OF DIAGRAM, SHOWN FOR 8 LEVEL CODE AND PARITY AND TWO STOPS.  
 1: BIT TIME = 16 CLOCK CYCLES.  
 2: IF TRANSMITTER IS INACTIVE THE START PULSE WILL APPEAR ON LINE 1 TO 2 CLOCK CYCLES AFTER THE DATA STROBE OCCURS. SEE DETAIL.  
 3: SINCE TRANSMITTER IS DOUBLE BUFFERED ANOTHER DATA STROBE CAN OCCUR ANYWHERE DURING TRANSMISSION OF CHARACTER 1 AFTER TBMT GOES HIGH.

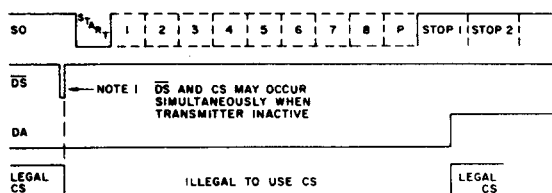


**Fig.27 UAR/T — TRANSMITTER TIMING**



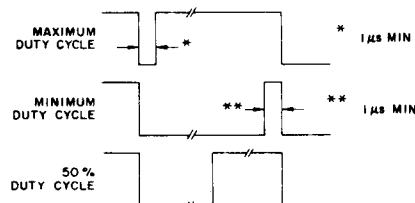
**Fig. 28 TRANSMITTER AT START BIT NOT A TEST POINT**

**Fig.29 TRANSMITTER AT START BIT**



NOTE: CONTROL STROBE MAY BE HARDWIRED TO "1" IN THAT CASE CONTROL DATA BITS MUST BE STABLE DURING "ILLEGAL CS" TIME.

**Fig.30 ALLOWABLE POINTS TO USE CONTROL STROBE**

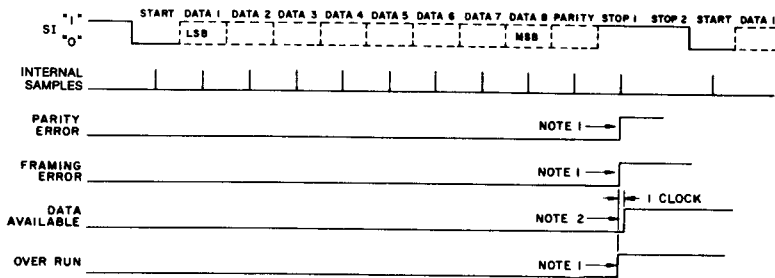


ANY PULSE WIDTH WHICH MEETS ABOVE CRITERIA IS ALLOWABLE.

**Fig.31 ALLOWABLE TCP, RCP**

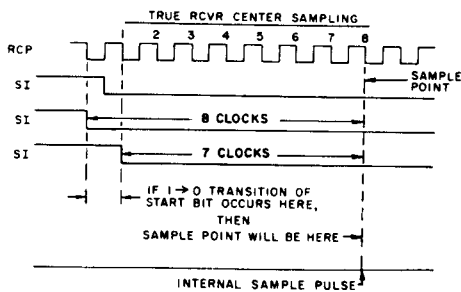


**TIMING DIAGRAMS**

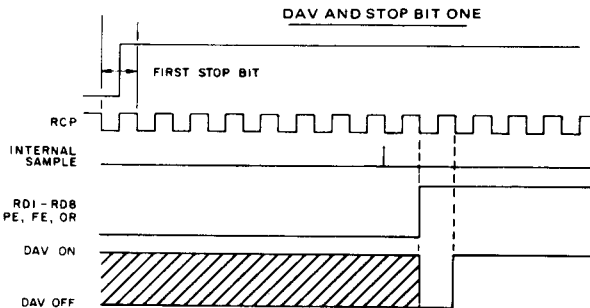


- NOTES:**
1. THIS IS THE TIME WHEN THE ERROR CONDITIONS ARE INDICATED, IF ERROR OCCURS.
  2. DATA AVAILABLE IS SET ONLY WHEN THE RECEIVED DATA, PE, FE, OR HAS BEEN TRANSFERRED TO THE HOLDING REGISTERS. (SEE RECEIVER BLOCK DIAGRAM).
  3. ALL INFORMATION IS GOOD IN HOLDING REGISTER UNTIL DATA AVAILABLE TRIES TO SET FOR NEXT CHARACTER.
  4. ABOVE SHOWN FOR 8 LEVEL CODE PARITY AND TWO STOP. FOR NO PARITY, STOP BITS FOLLOW DATA.
  5. FOR ALL LEVEL CODE THE DATA IN THE HOLDING REGISTER IS *RIGHT JUSTIFIED*; THAT IS, LSB ALWAYS APPEARS IN RD1 (PIN 12).

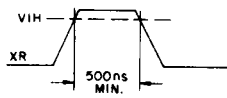
**Fig.32 UART/T — RECEIVER TIMING**



**Fig.33**

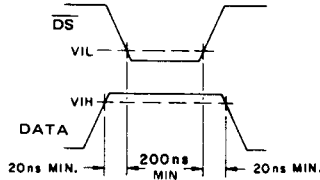


**Fig.34 RECEIVER DURING 1ST STOP BIT**

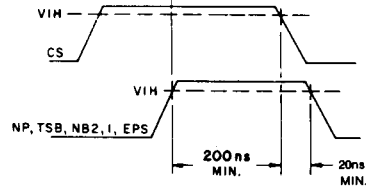


WHEN NOT IN USE, XR MUST BE HELD AT GND.  
XR RESETS EVERY REGISTER EXCEPT THE CONTROL REGISTER. SO, TBMT, EOC ARE RESET TO SV ALL OTHER OUTPUTS RESET TO OV.

**Fig.35 XR PULSE**

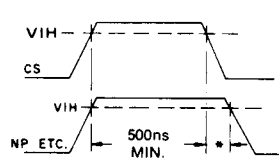


**Fig.36 DS**



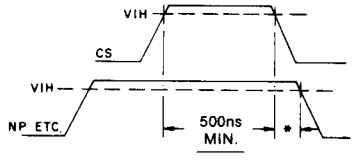
CONTROL BITS MUST BE STABLE FOR LAST 200ns OF CS.

**Fig.37a CS**



CONTROL STROBE AND CONTROL BITS MUST BE 500ns MINIMUM.

**Fig.37b**



LEADING EDGE OF CONTROL DATA IS NOT CRITICAL AS LONG AS TRAILING EDGE AND PULSE WIDTH SPECS ARE OBSERVED.

**Fig.38**

TELECOM



TIMING DIAGRAMS

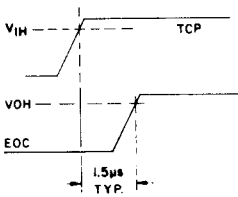


Fig.39 EOC TURN-ON

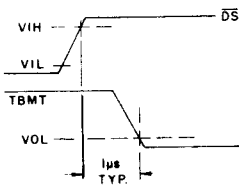


Fig.40 TBMT TURN-OFF

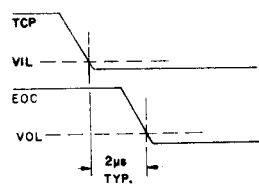


Fig.41 EOC TURN-OFF

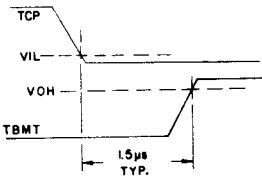


Fig.42 TBMT TURN-ON

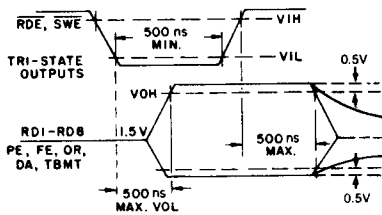


Fig.43 RDE, SWE

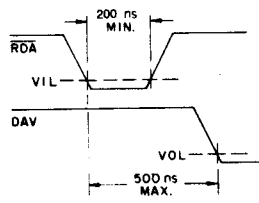


Fig.44 RDAV

TYPICAL CHARACTERISTIC CURVES

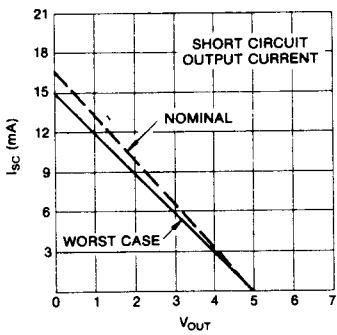


Fig.45 SHORT CIRCUIT OUTPUT CURRENT (only 1 output may be shorted at a time)

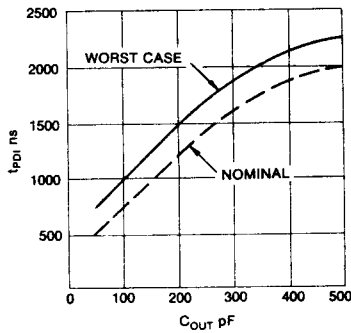


Fig.46 RD1-RD8, PE, FE, OR, TBMT, DAV

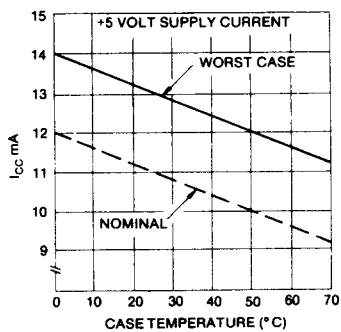


Fig.47 +5 VOLT SUPPLY CURRENT

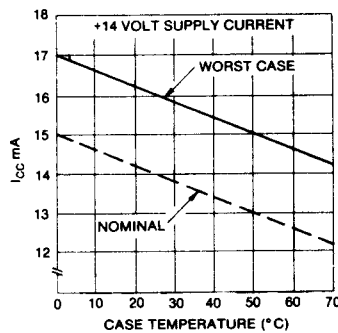


Fig.48 +14 VOLT SUPPLY CURRENT (AY-3-1014A only)